

MOTOR SPECIFICATION SHEET

MODEL : SF-JRGD 5HP, Gear Ratio 1/15 (LT)

USED FOR : GEAR MOTOR

DESCRIPTION	DETAIL				
PHASE	3				
MODEL NAME	SF-JRGD				
RATED OUTPUT, HP (kW)	5 (3.7)				
POLE	4				
CODE	MEATH CODE : 1G7015-0370N-LT0				
OUTLINE DRAWING NO.	OMM14O845-B				
RATED VOLTAGE (V)	220	380	415	220	440
RATED FREQUENCY (Hz)	50	50	50	60	60
RATED CURRENT (A)	13.3	7.7	7.3	13.0	6.6
RATED SPEED (min ⁻¹)	99	99	99	118	120
THERMAL CLASS	155(F)				
RATING	S1 (CONTINUOUS)				
ENCLOSURE CONSTRUCTION	TOTALLY ENCLOSED FAN COOLED				
DEGREES OF PROTECTION	IP55				
METHOD OF COOLING	IC411				
FRAME NO.	112M				
WEIGHT (kg)	82				
STANDARD	IEC 60034-1, JEC-2137-2000				
INSTALLATION	FOOT MOUNTED				
ROTATION	CCW (VIEWED FROM SHAFT END)				
BEARING	LOAD SIDE : 6308ZZ				
	OPPOSITE SIDE : 6206ZZ				
BEARING GREASE	UREA GREASE				
CIRCUMSTANCE CONDITION	AMBIENT TEMPERATURE : -20 ~ +40°C				
	AMBIENT HUMIDITY : 95%RH OR LESS				
	ABOVE SEA LEVEL : 1000m OR LESS				
	ENVIRONMENT : NO BURSTING/EROSIVE GAS OR VAPOR				
COLOR	MUNSELL N5.5 (GRAY)				
TERMINAL BOX	NO. OF LEAD WIRES : 6				
	SOURCE CONNECTION : TERMINAL BLOCK				
INSULATION RESISTANCE	BY DC 500V MEGGER - ≥100MΩ				
DIELECTRIC TEST	AC 50Hz 1800V - 1min. (Based on rated voltage 380V)				
GEAR RATIO	1/15				
GEAR LUBRICANT	GREASE (Filled from factory.)				
SERVICE FACTOR	1.4				
MATERIAL	FRAME : STEEL PLATE				
	BRACKET (GEAR SIDE) : N/A (Frame is directly connected to Gear case)				
	BRACKET (OPP SIDE) : ALUMINIUM				
	GEAR CASE : CAST IRON				
	SHAFT (MOTOR) : STEEL				
	SHAFT (GEAR OUTPUT) : STEEL				
	STATOR CORE : ELECTRICAL STEEL				
	WIRE : ENAMELLED COPPER MAGNET WIRE				
	INSULATOR : POLYESTER FILM SATURATED WITH RESIN				
	VARNISH : EPOXY DENATURALIZATION POLYESTER				
	ROTOR CORE : ELECTRICAL STEEL				
	CONDUCTOR : ALUMINIUM				
	TERMINAL BOX : STEEL PLATE				
PAINTING : POLYURETHANE RESIN					
PRODUCTION COUNTRY	THAILAND				

Specifications subject to change without notice.

SPECIFICATION SHEET NO.				
SS-M-1461-A				

MODEL SF-JRGD THREE PHASE INDUCTION MOTOR OUTLINE DRAWING

GEAR MOTOR
 TOTALLY ENCLOSED FAN COOLED
 DEGREE OF PROTECTION IP55
 DUST & WATER JET PROOF

CUSTOMER : _____
 USER _____
 FOR _____
 CUSTOMER'S ORDER NO. _____
 QUANTITY _____
 MFG. ORDER NO. _____

TYPE	HP(kW)	POLE	Hz	VOLT		
SF-JRGD	5(3.7)	4	50	220	380	415
			60	220	440	
SF-JRGD	5(3.7)	4	50	380	415	
			60	380	440	

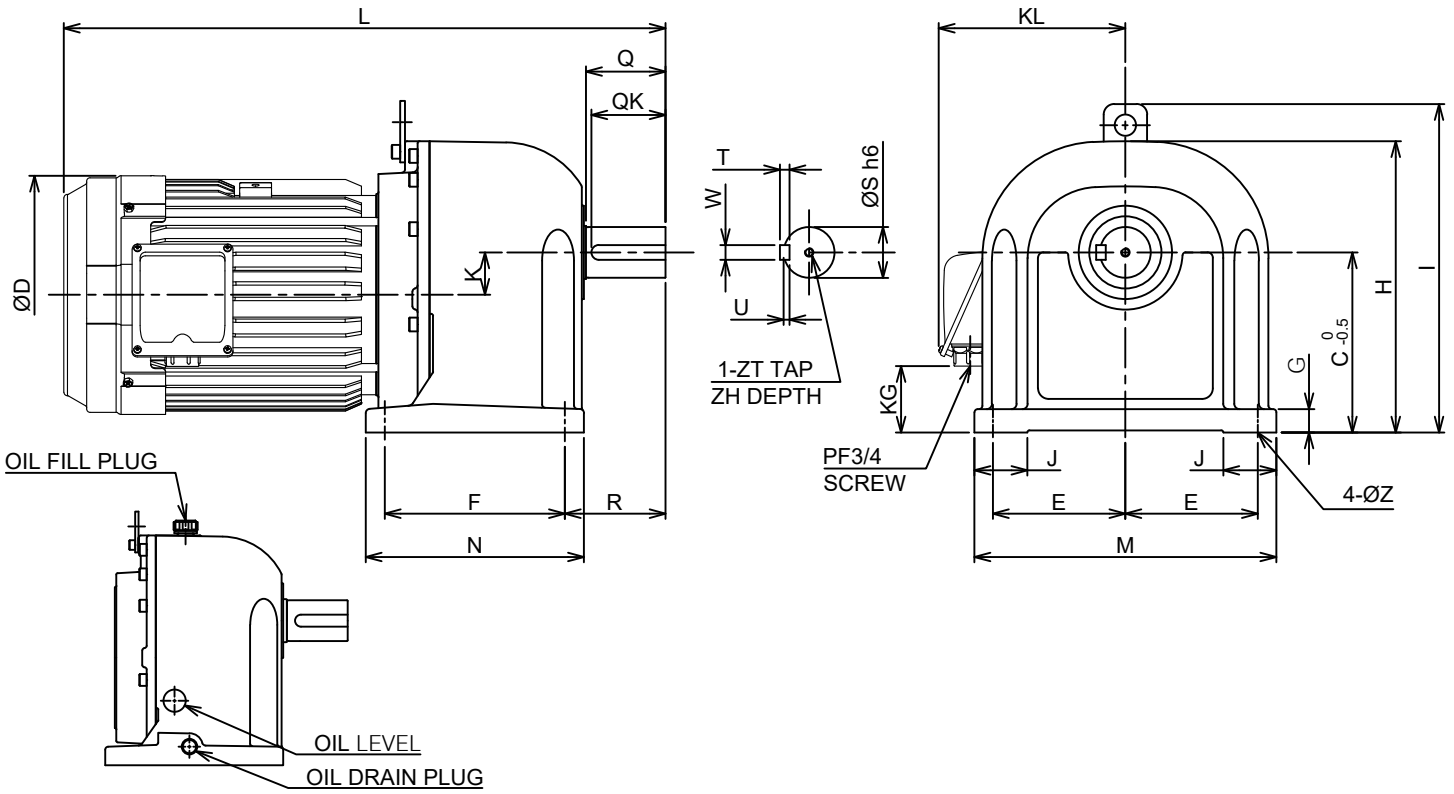

GEAR RATIO 1/40 ~ 1/60

GEAR RATIO	DIMENSIONS (mm.)																							WEIGHT (Kg)	
	L	Q	QK	ØD	K	F	R	N	T	W	U	ZT	ZH	ØS	KL	KG	J	E	M	G	C	H	I		ØZ
1/3 ~ 1/30	568	75	70	226	40	170	95	206	9	14	5.5	M8	12	48	176	63	50	125	285	22	170	275	310	15	82.0
1/40, 1/50	609	82	71	226	50	200	107	240	10	16	6	M10	18	55	176	78	60	130	300	25	195	330	345	19	99.0
1/60	642.5	90	72	226	60	230	120	280	11	18	7	M10	18	60	176	103	70	150	350	30	230	380	395	24	126.2

RATING	INS. CLASS	AMB. TEMP.	COLOR	NO. OF LEAD WIRES	LUBRICANTION		ROTATION DIRECTION (VIEWED FROM OUTPUT SHAFT END)
					GEAR RATIO	TYPE	
S1	155(F)	40°C	GRAY MUNSELL N5.5	6	1/3	FILLED GREASE	CLOCKWISE (CW)
					1/5 ~ 1/30	FILLED GREASE	COUNTERCLOCKWISE (CCW)
					1/40 ~ 1/60	OIL ⁽¹⁾	CLOCKWISE (CW)

NOTE: (1) PLEASE FILL IN OIL BEFORE FIRST TIME USAGE (SEE DETAIL IN THE INSTRUCTION MANUAL)

MITSUBISHI ELECTRIC AUTOMATION (THAILAND) CO.,LTD.



DIMENSION IN mm.
 SCALE : NTS

OUTLINE DRAWING NO.

0 M M 1 4 0 8 4 5

REV.

B