

MOTOR SPECIFICATION SHEET

MODEL : CNHM3-6115-21 (LT) (Motor model : SF-JRG 3HP 4P)

USED FOR : GEAR MOTOR

DESCRIPTION	DETAIL				
PHASE	3				
MODEL NAME	CNHM3-6115-21				
RATED OUTPUT, HP (kW)	3 (2.2)				
POLE	4				
CODE	MEATH CODE : 1G1021-030N61152				
OUTLINE DRAWING NO.	OMM04O443-B				
RATED VOLTAGE (V)	220	380	415	220	440
RATED FREQUENCY (Hz)	50	50	50	60	60
RATED CURRENT (A)	8.7	5.0	4.9	8.5	4.6
RATED SPEED (min ⁻¹) *	68	68	68	81	82
THERMAL CLASS	155(F)				
RATING	S1 (CONTINUOUS)				
ENCLOSURE CONSTRUCTION	TOTALLY ENCLOSED FAN COOLED				
DEGREES OF PROTECTION	IP55				
METHOD OF COOLING	IC411				
FRAME NO.	100L				
WEIGHT (kg)	38				
STANDARD	IEC 60034-1, JEC-2137-2000				
INSTALLATION	FOOT MOUNTED				
ROTATION	CCW (VIEWED FROM SHAFT END)				
BEARING	LOAD SIDE : 6205ZZ				
	OPPOSITE SIDE : 6205ZZ				
BEARING GREASE	UREA GREASE				
CIRCUMSTANCE CONDITION	AMBIENT TEMPERATURE : -20 ~ +40°C				
	AMBIENT HUMIDITY : 95%RH OR LESS				
	ABOVE SEA LEVEL : 1000m OR LESS				
	ENVIRONMENT : NO BURSTING/EROSIVE GAS OR VAPOR				
COLOR	MUNSELL N5.5 (GRAY)				
TERMINAL BOX	NO. OF LEAD WIRES : 6				
	SOURCE CONNECTION : TERMINAL BLOCK				
INSULATION RESISTANCE	BY DC 500V MEGGER - ≥100MΩ				
DIELECTRIC TEST	AC 50Hz 1800V - 1min. (Based on rated voltage 380V)				
GEAR RATIO	1 : 21				
GEAR LUBRICANT	GREASE (Filled from factory.)				
SERVICE FACTOR	1.41				
MATERIAL	FRAME : STEEL PLATE				
	BRACKET (GEAR SIDE) : CAST IRON				
	BRACKET (OPP SIDE) : ALUMINIUM				
	GEAR CASE : CAST IRON				
	SHAFT (MOTOR) : STEEL				
	SHAFT (GEAR OUTPUT) : STEEL				
	STATOR CORE : ELECTRICAL STEEL				
	WIRE : ENAMELLED COPPER MAGNET WIRE				
	INSULATOR : POLYESTER FILM SATURATED WITH RESIN				
	VARNISH : EPOXY DENATURALIZATION POLYESTER				
	ROTOR CORE : ELECTRICAL STEEL				
	CONDUCTOR : ALUMINIUM				
	TERMINAL BOX : STEEL PLATE				
PAINTING : POLYURETHANE RESIN					
PRODUCTION COUNTRY	THAILAND				

* This value is calculated by MOTOR RATED SPEED / GEAR RATIO.

(Catalog value is specified by follow Gear maker specification, 50/60Hz = 69/83min⁻¹.)

Specifications subject to change without notice.

SPECIFICATION SHEET NO.				
SS-M-0396-A				

MODEL CNHM THREE PHASE INDUCTION MOTOR OUTLINE DRAWING

GEAR MOTOR

TOTALLY ENCLOSED FAN COOLED

DEGREES OF PROTECTION IP55

DUST & WATER JET PROOF

CUSTOMER

USER

FOR

CUSTOMER'S

ORDER NO.

QUANTITY

MFG.

ORDER NO.

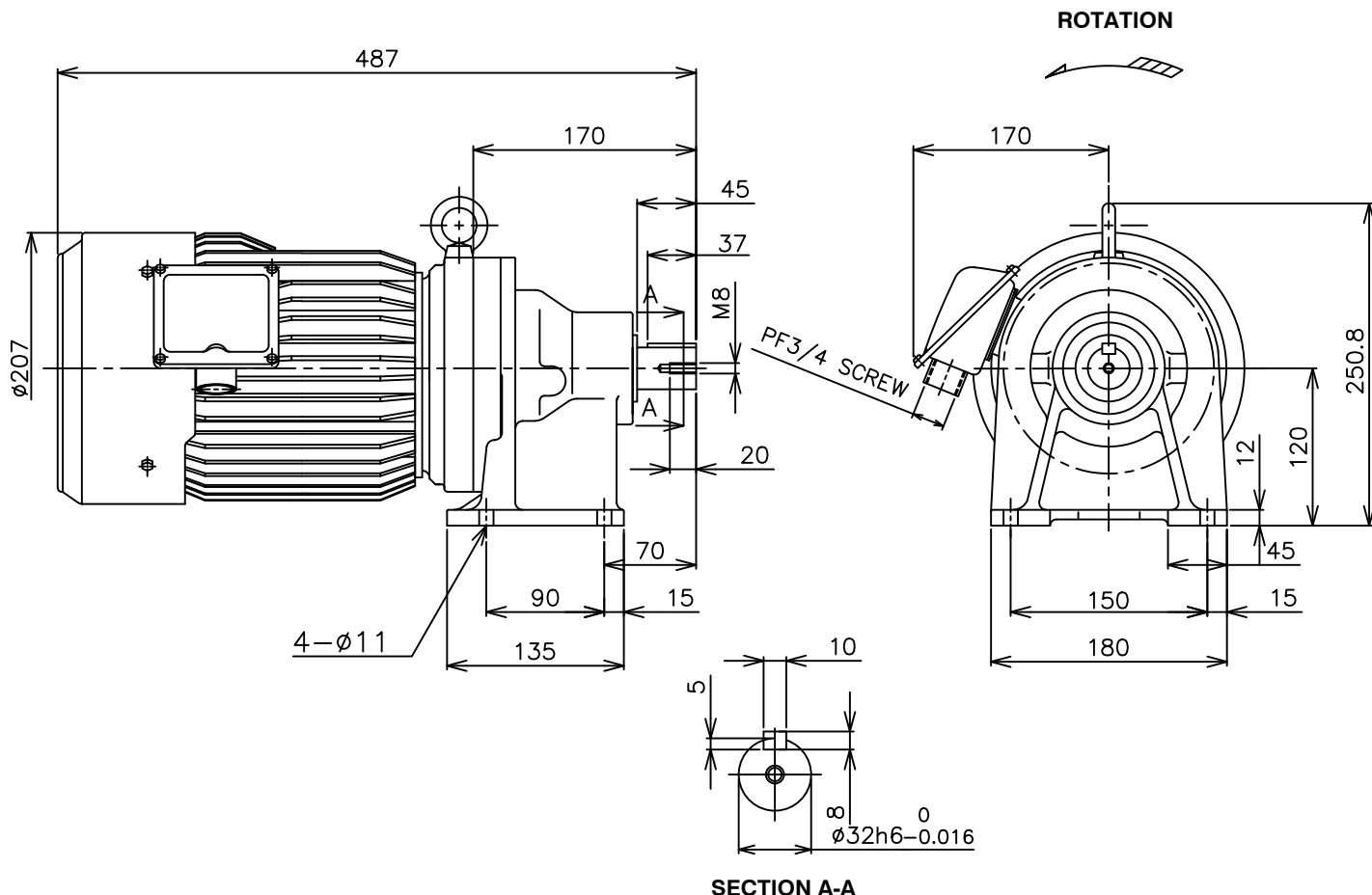

SECTION A-A

YOUR ORDER	MOTOR FRAME SIZE	RATING	TH. CLASS	AMB. TEMP	BEARINGS		COLOR	DIRECTION OF ROTATION	NO. OF LEAD WIRES	REMARKS
					LOAD SIDE	OPP. SIDE				
	100L	S1 (CONT.)	155(F)	40°C	6205ZZ	6205ZZ	GRAY (MUNSELL N5.5)	CCW	6	

YOUR ORDER	MODEL NAME	RATIO	SERVICE FACTOR	MOTOR OUTPUT		POLE	HERTZ	VOLT	OUTPUT SPEED (rpm)	LUBRICATION TYPE	WEIGHT (kg)
				HP	KW						
	CNHM3-6110-6	1:6	1.61	3	2.2	4	50 60	220/380/415 220/440	242 292	GREASE ⁽¹⁾	38
	CNHM3-6110-11	1:11	1.61	3	2.2	4	50 60	220/380/415 220/440	132 159		
	CNHM3-6110-15	1:15	1.61	3	2.2	4	50 60	220/380/415 220/440	97 117		
	CNHM3-6110-17	1:17	1.45	3	2.2	4	50 60	220/380/415 220/440	85 103		
	CNHM3-6115-21	1:21	1.41	3	2.2	4	50 60	220/380/415 220/440	69 83		

NOTE : (1) Grease had been filled from manufacturer already.

mitsubishi electric automation (thailand) co., ltd.

		OUTLINE DRAWING NO. 0 M M 0 4 0 4 4 3	REV. B
	DIMENSION IN mm.		
	SCALE : NTS		