

MOTOR SPECIFICATION SHEET

MODEL : CNHM2-6100-17 (LT) (Motor model : SF-JRG 2HP 4P)

USED FOR : GEAR MOTOR

DESCRIPTION	DETAIL				
PHASE	3				
MODEL NAME	CNHM2-6100-17				
RATED OUTPUT, HP (kW)	2 (1.5)				
POLE	4				
CODE	MEATH CODE : 1G1017-020N61002				
OUTLINE DRAWING NO.	OMM94O378-A				
RATED VOLTAGE (V)	220	380	415	220	440
RATED FREQUENCY (Hz)	50	50	50	60	60
RATED CURRENT (A)	5.9	3.4	3.4	5.5	3.1
RATED SPEED (min ⁻¹) *	84	84	85	101	102
THERMAL CLASS	155(F)				
RATING	S1 (CONTINUOUS)				
ENCLOSURE CONSTRUCTION	TOTALLY ENCLOSED FAN COOLED				
DEGREES OF PROTECTION	IP55				
METHOD OF COOLING	IC411				
FRAME NO.	90L				
WEIGHT (kg)	31				
STANDARD	IEC 60034-1, JEC-2137-2000				
INSTALLATION	FOOT MOUNTED				
ROTATION	CCW (VIEWED FROM SHAFT END)				
BEARING	LOAD SIDE : 6204ZZ				
	OPPOSITE SIDE : 6204ZZ				
BEARING GREASE	UREA GREASE				
CIRCUMSTANCE CONDITION	AMBIENT TEMPERATURE : -20 ~ +40°C				
	AMBIENT HUMIDITY : 95%RH OR LESS				
	ABOVE SEA LEVEL : 1000m OR LESS				
	ENVIRONMENT : NO BURSTING/EROSIVE GAS OR VAPOR				
COLOR	MUNSELL N5.5 (GRAY)				
TERMINAL BOX	NO. OF LEAD WIRES : 6				
	SOURCE CONNECTION : TERMINAL BLOCK				
INSULATION RESISTANCE	BY DC 500V MEGGER - ≥100MΩ				
DIELECTRIC TEST	AC 50Hz 1800V - 1min. (Based on rated voltage 380V)				
GEAR RATIO	1 : 17				
GEAR LUBRICANT	GREASE (Filled from factory.)				
SERVICE FACTOR	1.33				
MATERIAL	FRAME : STEEL PLATE				
	BRACKET (GEAR SIDE) : CAST IRON				
	BRACKET (OPP SIDE) : ALUMINIUM				
	GEAR CASE : CAST IRON				
	SHAFT (MOTOR) : STEEL				
	SHAFT (GEAR OUTPUT) : STEEL				
	STATOR CORE : ELECTRICAL STEEL				
	WIRE : ENAMELLED COPPER MAGNET WIRE				
	INSULATOR : POLYESTER FILM				
	VARNISH : EPOXY DENATURALIZATION POLYESTER				
	ROTOR CORE : ELECTRICAL STEEL				
	CONDUCTOR : ALUMINIUM				
	TERMINAL BOX : STEEL PLATE				
PAINTING : POLYURETHANE RESIN					
PRODUCTION COUNTRY	THAILAND				

* This value is calculated by MOTOR RATED SPEED / GEAR RATIO.

(Catalog value is specified by follow Gear maker specification, 50/60Hz = 85/103min⁻¹.)

Specifications subject to change without notice.

SPECIFICATION SHEET NO.				
SS-M-9386-A				

MODEL CNHM THREE PHASE INDUCTION MOTOR OUTLINE DRAWING

GEAR MOTOR

TOTALLY ENCLOSED FAN COOLED

DEGREES OF PROTECTION IP55

DUST & WATER JET PROOF

CUSTOMER

USER

FOR

CUSTOMER'S

ORDER NO.

QUANTITY

MFG.

ORDER NO.

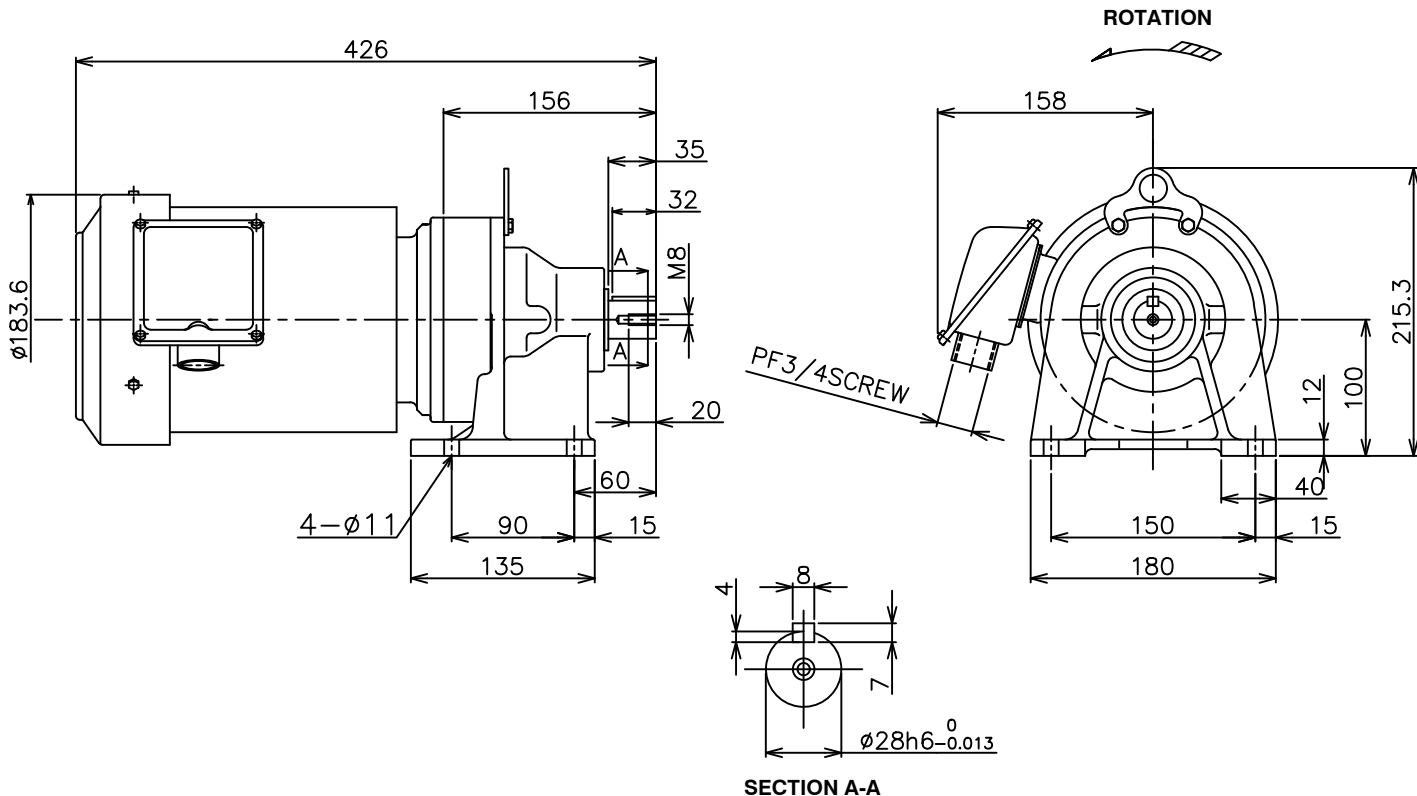

YOUR ORDER	MOTOR FRAME SIZE	RATING	TH. CLASS	AMB. TEMP	BEARINGS		COLOR	DIRECTION OF ROTATION	NO. OF LEAD WIRES	REMARKS
					LOAD SIDE	OPP. SIDE				
	90L	S1 (CONT.)	155(F)	40°C	6204ZZ	6204ZZ	GRAY (MUNSELL N5.5)	CCW	6	

YOUR ORDER	MODEL NAME	RATIO	SERVICE FACTOR	MOTOR OUTPUT		POLE	HERTZ	VOLT	OUTPUT SPEED (rpm)	LUBRICATION TYPE	WEIGHT (kg)
				HP	kW						
	CNHM2-6100-6	1:6	1.57	2	1.5	4	50 60	220/380/415 220/440	242 292	GREASE ⁽¹⁾	31
	CNHM2-6100-11	1:11	1.57	2	1.5	4	50 60	220/380/415 220/440	132 159		
	CNHM2-6100-15	1:15	1.57	2	1.5	4	50 60	220/380/415 220/440	97 117		
	CNHM2-6100-17	1:17	1.33	2	1.5	4	50 60	220/380/415 220/440	85 103		
	CNHM2-6105-21	1:21	1.52	2	1.5	4	50 60	220/380/415 220/440	69 83		

NOTE : (1) Grease had been filled from manufacturer already.

MITSUBISHI ELECTRIC AUTOMATION (THAILAND) CO., LTD.

		OUTLINE DRAWING NO.	0 M M 9 4 0 3 7 8	REV.
	DIMENSION IN mm.			
SCALE : NTS				