

MOTOR SPECIFICATION SHEET

MODEL : CNHM5-6120-15 (LT) (Motor model : SF-JRG 5HP 4P)

USED FOR : GEAR MOTOR

DESCRIPTION	DETAIL				
PHASE	3				
MODEL NAME	CNHM5-6120-15				
RATED OUTPUT, HP (kW)	5 (3.7)				
POLE	4				
CODE	MEATH CODE : 1G1015-050N61202				
OUTLINE DRAWING NO.	OMM14O444-A				
RATED VOLTAGE (V)	220	380	415	220	440
RATED FREQUENCY (Hz)	50	50	50	60	60
RATED CURRENT (A)	13.7	7.9	7.7	13.5	7.2
RATED SPEED (min ⁻¹) *	95	95	95	114	115
THERMAL CLASS	155(F)				
RATING	S1 (CONTINUOUS)				
ENCLOSURE CONSTRUCTION	TOTALLY ENCLOSED FAN COOLED				
DEGREES OF PROTECTION	IP55				
METHOD OF COOLING	IC411				
FRAME NO.	112M				
WEIGHT (kg)	55				
STANDARD	IEC 60034-1, JEC-2137-2000				
INSTALLATION	FOOT MOUNTED				
ROTATION	CCW (VIEWED FROM SHAFT END)				
BEARING	LOAD SIDE : 6206ZZ				
	OPPOSITE SIDE : 6206ZZ				
BEARING GREASE	UREA GREASE				
CIRCUMSTANCE CONDITION	AMBIENT TEMPERATURE : -20 ~ +40°C				
	AMBIENT HUMIDITY : 95%RH OR LESS				
	ABOVE SEA LEVEL : 1000m OR LESS				
	ENVIRONMENT : NO BURSTING/EROSIVE GAS OR VAPOR				
COLOR	MUNSELL N5.5 (GRAY)				
TERMINAL BOX	NO. OF LEAD WIRES : 6				
	SOURCE CONNECTION : TERMINAL BLOCK				
INSULATION RESISTANCE	BY DC 500V MEGGER - ≥100MΩ				
DIELECTRIC TEST	AC 50Hz 1800V - 1min. (Based on rated voltage 380V)				
GEAR RATIO	1:15				
GEAR LUBRICANT	GREASE (Filled from factory.)				
SERVICE FACTOR	1.37				
MATERIAL	FRAME : STEEL PLATE				
	BRACKET (GEAR SIDE) : CAST IRON				
	BRACKET (OPP SIDE) : ALUMINIUM				
	GEAR CASE : CAST IRON				
	SHAFT (MOTOR) : STEEL				
	SHAFT (GEAR OUTPUT) : STEEL				
	STATOR CORE : ELECTRICAL STEEL				
	WIRE : ENAMELLED COPPER MAGNET WIRE				
	INSULATOR : POLYESTER FILM SATURATED WITH RESIN				
	VARNISH : EPOXY DENATURALIZATION POLYESTER				
	ROTOR CORE : ELECTRICAL STEEL				
	CONDUCTOR : ALUMINIUM				
	TERMINAL BOX : STEEL PLATE				
PAINTING : POLYURETHANE RESIN					
PRODUCTION COUNTRY	THAILAND				

* This value is calculated by MOTOR RATED SPEED / GEAR RATIO.

(Catalog value is specified by follow Gear maker specification, 50/60Hz = 97/117min⁻¹.)

Specifications subject to change without notice.

SPECIFICATION SHEET NO.				
SS-M-1405-A				

MODEL CNHM THREE PHASE INDUCTION MOTOR OUTLINE DRAWING

GEAR MOTOR
TOTALLY ENCLOSED FAN COOLED
DEGREES OF PROTECTION IP55
DUST & WATER JET PROOF

CUSTOMER _____
USER _____
FOR _____
CUSTOMER'S ORDER NO. _____
QUANTITY _____
MFG. ORDER NO. _____

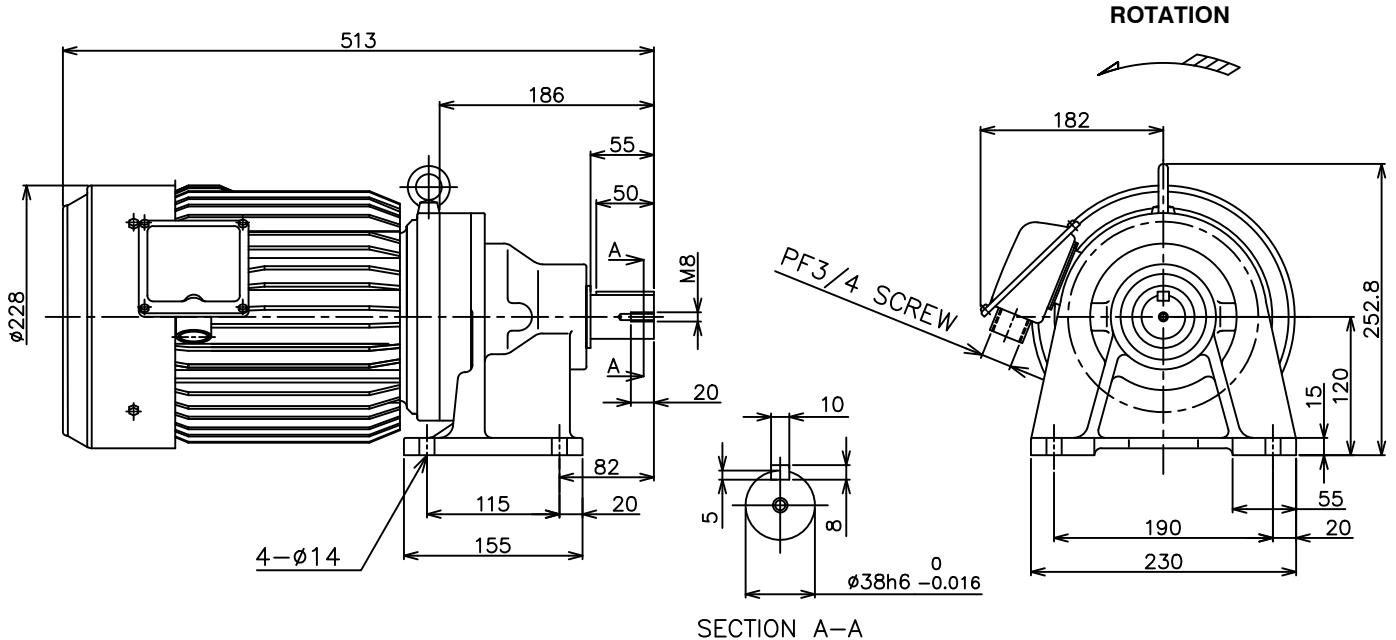

YOUR ORDER	MOTOR FRAME SIZE	RATING	TH. CLASS	AMB. TEMP	BEARINGS		COLOR	DIRECTION OF ROTATION	NO. OF LEAD WIRES	REMARKS
					LOAD SIDE	OPP. SIDE				
	112M	S1 (CONT.)	155(F)	40°C	6206ZZ	6206ZZ	GRAY (MUNSELL N5.5)	CCW	6	

YOUR ORDER	MODEL NAME	RATIO	SERVICE FACTOR	MOTOR OUTPUT		POLE	HERTZ	VOLT	OUTPUT SPEED (rpm)	LUBRICATION TYPE	WEIGHT (kg)
				HP	KW						
	CNHM5-6120-6	1:6	1.37	5	3.7	4	50	220/380/415	242	GREASE ⁽¹⁾	55
							60	220/440	292		
	CNHM5-6120-11	1:11	1.37	5	3.7	4	50	220/380/415	132		
							60	220/440	159		
	CNHM5-6120-15	1:15	1.37	5	3.7	4	50	220/380/415	97		
							60	220/440	117		
	CNHM5-6125-17	1:17	1.53	5	3.7	4	50	220/380/415	85		
							60	220/440	103		
	CNHM5-6125-21	1:21	1.29	5	3.7	4	50	220/380/415	69		
							60	220/440	83		
	CNHM5-6120-6	1:6	1.37	5	3.7	4	50	380/415	242		
							60	380/440	292		
	CNHM5-6120-11	1:11	1.37	5	3.7	4	50	380/415	132		
							60	380/440	159		
	CNHM5-6120-15	1:15	1.37	5	3.7	4	50	380/415	97		
							60	380/440	117		
	CNHM5-6125-17	1:17	1.53	5	3.7	4	50	380/415	85		
							60	380/440	103		
	CNHM5-6125-21	1:21	1.29	5	3.7	4	50	380/415	69		
							60	380/440	83		

NOTE : (1) Grease had been filled from manufacturer already.

MITSUBISHI ELECTRIC AUTOMATION (THAILAND) CO., LTD.

		OUTLINE DRAWING NO. 0 M M 1 4 0 4 4 4	REV. A
	DIMENSION IN mm. SCALE : NTS		