

MOTOR SPECIFICATION SHEET

MODEL : SF-QRGH 7.5HP 4P RATIO 1:10 (HT)

USED FOR : GEAR MOTOR

DESCRIPTION	DETAIL		
PHASE	3		
MODEL NAME	SF-QRGH		
RATED OUTPUT, HP (kW)	7.5 (5.5)		
POLE	4		
CODE	MEATH CODE : 1G7010-0550H-HTQR0		
OUTLINE DRAWING NO.	ONM24O345-A		
RATED VOLTAGE (V)	380	415	
RATED FREQUENCY (Hz)	50	50	
RATED CURRENT (A)	11.7	11.7	
RATED SPEED (min ⁻¹)	150	151	
RATED EFFICIENCY (%)	85.8	85.6	
EFFICIENCY CLASS	IE1		
THERMAL CLASS	155(F)		
RATING	S1 (CONTINUOUS)		
ENCLOSURE CONSTRUCTION	TOTALLY ENCLOSED FAN COOLED		
DEGREES OF PROTECTION	IP55		
METHOD OF COOLING	IC411		
FRAME NO.	132S		
WEIGHT (kg)	109		
STANDARD	IEC 60034-1, IEC 60034-30-1		
INSTALLATION	FOOT MOUNTED		
ROTATION	CCW (VIEWED FROM SHAFT END)		
BEARING	LOAD SIDE	: 6309ZZ	
	OPPOSITE SIDE	: 6207ZZ	
BEARING GREASE	UREA GREASE		
CIRCUMSTANCE CONDITION	AMBIENT TEMPERATURE	: -20 ~ +40°C	
	AMBIENT HUMIDITY	: 95%RH OR LESS	
	ABOVE SEA LEVEL	: 1000m OR LESS	
	ENVIRONMENT	: NO BURSTING/EROSIVE GAS OR VAPOR	
COLOR	MUNSELL N1.5 (BLACK)		
TERMINAL BOX	NO. OF LEAD WIRES	: 6	
	SOURCE CONNECTION	: TERMINAL BLOCK	
GEAR RATIO	1:10		
GEAR LUBRICANT	OIL (Must be filled by user.)		
SERVICE FACTOR	1.4		
MATERIAL	FRAME	: STEEL PLATE	
	BRACKET (GEAR SIDE)	: N/A (Frame is directly connected to Gear case)	
	BRACKET (OPP SIDE)	: ALUMINIUM	
	GEAR CASE	: CAST IRON	
	SHAFT (MOTOR)	: STEEL	
	SHAFT (GEAR OUTPUT)	: STEEL	
	STATOR CORE	: ELECTRICAL STEEL	
	WIRE	: ENAMELLED COPPER MAGNET WIRE	
	ROTOR CORE	: ELECTRICAL STEEL	
	CONDUCTOR	: ALUMINIUM	
	TERMINAL BOX	: STEEL PLATE	
	PAINTING	: POLYURETHANE RESIN	
PRODUCTION COUNTRY	THAILAND		

Specifications subject to change without notice.

SPECIFICATION SHEET NO.

SS-M-2927-B

MODEL SF-QRGH THREE PHASE INDUCTION MOTOR OUTLINE DRAWING

GEAR MOTOR
 TOTALLY ENCLOSED FAN COOLED
 DEGREES OF PROTECTION IP55
 DUST & WATER JET PROOF

CUSTOMER _____
 USER _____
 FOR _____
 CUSTOMER'S ORDER NO. _____
 QUANTITY _____
 MFG. ORDER NO. _____

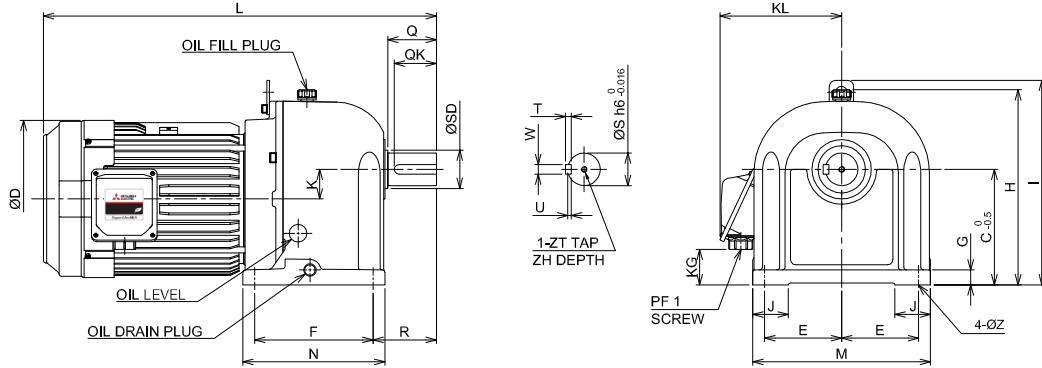

YOUR ORDER	GEAR RATIO	DIMENSION(mm.)																			WEIGHT (kg.)						
		L	Q	QK	ØD	K	F	R	N	T	W	U	ZT	ZH	ØS	ØSD	KL	KG	J	E		M	G	C	H	I	ØZ
	1:3~1:30	663.5	82	71	266	50	200	107	240	10	16	6	M10	18	55	58	205	77	60	130	300	25	195	330	345	19	109
	1:40,1:50	697	90	72	266	60	230	120	280	11	18	7	M10	18	60	63	205	102	70	150	350	30	230	380	395	24	143

YOUR ORDER	MOTOR FRAME SIZE	RATING	TH. CLASS	AMB. TEMP	BEARINGS		COLOR	GEAR RATIO	DIRECTION OF ROTATION (VIEWED FROM SHAFT END)	NO. OF LEAD WIRES	REMARKS
					LOAD SIDE	OPP. SIDE					
	132S	S1 (CONT.)	155(F)	40°C	6309ZZ	6207ZZ	BLACK (MUNSELL N1.5)	1:3~1:30 1:40~1:50	CCW CW	6	

YOUR ORDER	RATIO	SERVICE FACTOR	MOTOR OUTPUT		POLE	VOLT	HERTZ	OUTPUT SPEED (min ⁻¹)	AMP.	IE CODE - RATED EFF.	TYPE	LUBRICATION TYPE
			HP	KW								
	1:3	1.4	7.5	5.5	4	220/380/415	50	500/500/500	20.2/11.7/11.6	IE1-84.7%/84.7%/84.7%	LT	OIL ⁽¹⁾
	1:5	1.4	7.5	5.5	4	220/380/415	50	295/295/300				
	1:10	1.4	7.5	5.5	4	220/380/415	50	150/150/151				
	1:15	1.4	7.5	5.5	4	220/380/415	50	101/101/102				
	1:20	1.4	7.5	5.5	4	220/380/415	50	76.5/76.5/77				
	1:25	1.4	7.5	5.5	4	220/380/415	50	61.5/61.5/62				
	1:30	1.4	7.5	5.5	4	220/380/415	50	47.5/47.5/47.5				
	1:40	1.4	7.5	5.5	4	220/380/415	50	37.5/37.5/37.5				
	1:50	1.4	7.5	5.5	4	220/380/415	50	29/29/29.5				
	1:3	1.4	7.5	5.5	4	380/415	50	500/500	11.7/11.7	IE1-85.8%/85.6%	HT	
	1:5	1.4	7.5	5.5	4	380/415	50	295/300				
	1:10	1.4	7.5	5.5	4	380/415	50	150/151				
	1:15	1.4	7.5	5.5	4	380/415	50	101/102				
	1:20	1.4	7.5	5.5	4	380/415	50	76.5/77				
	1:25	1.4	7.5	5.5	4	380/415	50	61.5/62				
	1:30	1.4	7.5	5.5	4	380/415	50	47.5/47.5				
	1:40	1.4	7.5	5.5	4	380/415	50	37.5/37.5				
	1:50	1.4	7.5	5.5	4	380/415	50	29/29.5				

NOTE : (1) PLEASE FILL IN OIL BEFORE FIRST TIME USAGE. (SEE DETAIL IN THE INSTRUCTION MANUAL)

MITSUBISHI ELECTRIC AUTOMATION (THAILAND) CO.,LTD.

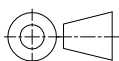

DIMENSION IN mm.
 SCALE : NTS

OUTLINE DRAWING NO.

ONM240345

REV.

A