

MOTOR SPECIFICATION SHEET

MODEL : SF-QR 1HP 6P IP44 (LT)

USED FOR : STANDARD

DESCRIPTION	DETAIL			
PHASE	3			
MODEL NAME	SF-QR			
RATED OUTPUT, HP (kW)	1 (0.75)			
POLE	6			
CODE	MEATH CODE : 1M002F-600075QRGC0			
OUTLINE DRAWING NO.	ONM94O198-C			
RATED VOLTAGE (V)	220	380	415	
RATED FREQUENCY (Hz)	50	50	50	
RATED CURRENT (A)	4.0	2.3	2.3	
RATED SPEED (min ⁻¹)	960	960	965	
RATED EFFICIENCY (%)	76.6	76.6	76.3	
EFFICIENCY CLASS	IE1			
THERMAL CLASS	130(B)			
RATING	S1 (CONTINUOUS)			
ENCLOSURE CONSTRUCTION	TOTALLY ENCLOSED FAN COOLED			
DEGREES OF PROTECTION	IP44			
METHOD OF COOLING	IC411			
FRAME NO.	90L			
WEIGHT (kg)	19			
STANDARD	IEC 60034-1, IEC 60034-30-1			
INSTALLATION	FOOT MOUNTED			
ROTATION	CCW (VIEWED FROM SHAFT END)			
BEARING	LOAD SIDE : 6205ZZ			
	OPPOSITE SIDE : 6204ZZ			
BEARING GREASE	UREA GREASE			
NOISE (dB.A)	61			
VIBRATION	V15			
CIRCUMSTANCE CONDITION	AMBIENT TEMPERATURE : -20 ~ +40°C			
	AMBIENT HUMIDITY : 95%RH OR LESS			
	ABOVE SEA LEVEL : 1000m OR LESS			
	ENVIRONMENT : NO BURSTING/EROSIVE GAS OR VAPOR			
COLOR	MUNSELL N1.5 (BLACK)			
TERMINAL BOX	NO. OF LEAD WIRES : 6			
	SOURCE CONNECTION : LEAD WIRES			
SHAFT SWING	≤0.03mm			
MATERIAL	FRAME : STEEL PLATE			
	BRACKET : ALUMINIUM			
	SHAFT : CARBON STEEL			
	STATOR CORE : ELECTRICAL STEEL			
	WIRE : ENAMELLED COPPER MAGNET WIRE			
	ROTOR CORE : ELECTRICAL STEEL			
	CONDUCTOR : ALUMINIUM			
	TERMINAL BOX : STEEL PLATE			
	PAINTING : ALKYD-NITROCELLULOSE RESIN			
PRODUCTION COUNTRY	THAILAND			

Specifications subject to change without notice.

SPECIFICATION SHEET NO.				
SS-N-9029-A				

MODEL SF-QR THREE PHASE INDUCTION MOTOR OUTLINE DRAWING

TOTALLY ENCLOSED FAN COOLED TYPE
DEGREES OF PROTECTION IP44

CUSTOMER _____
USER _____
FOR _____
CUSTOMER'S ORDER NO. _____
QUANTITY _____
MFG. ORDER NO. _____

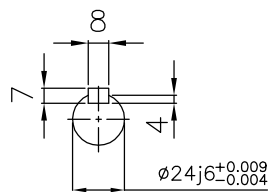
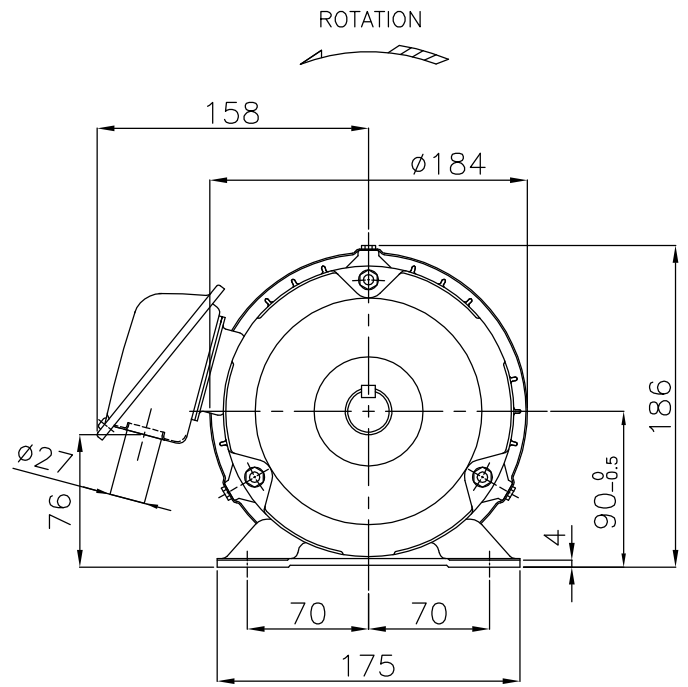
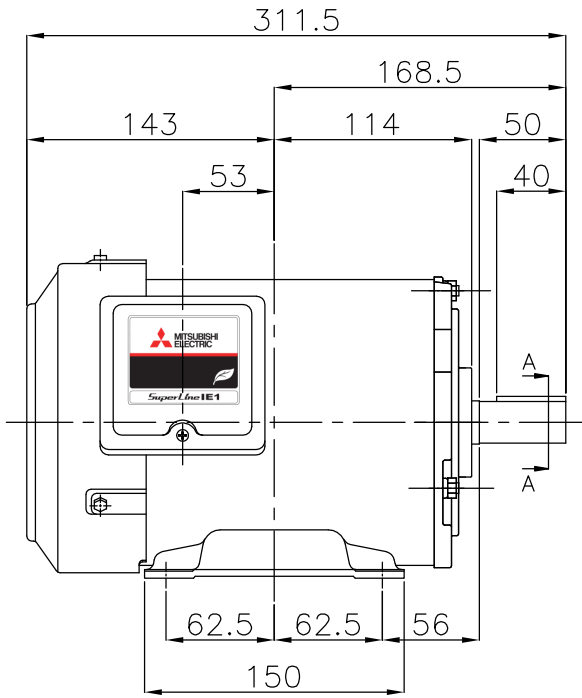

SECTION A-A

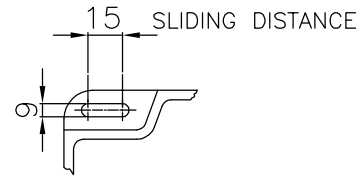

FRAME FOOT AS VIEWED FROM BELOW

YOUR ORDER	FRAME SIZE	RATING	TH. CLASS	AMB. TEMP.	BEARINGS		COLOR	DIRECTION OF ROTATION (VIEWED FROM SHAFT END)	NO. OF LEAD WIRES	REMARKS
					LOAD SIDE	OPP. SIDE				
	90L	S1 (CONT.)	130(B)	40°C	6205ZZ	6204ZZ	BLACK (MUNSELL N1.5)	CCW	6	

YOUR ORDER	OUTPUT		POLES	VOLTS	HERTZ	AMP.	RPM	IE CODE-RATED EFF.	REMARKS
	HP	KW							
	2	1.5	2	220/380/415	50	5.5/3.2/3.1	2870/2870/2900	IE1 81.5%/81.5%/82.6%	LT
	3	2.2	2	220/380/415	50	7.8/4.5/4.3	2850/2850/2880	IE1 82.9%/82.9%/84.6%	LT
	2	1.5	4	220/380/415	50	6.1/3.5/3.5	1430/1430/1440	IE1 83.0%/83.0%/83.5%	LT
	1	0.75	6	220/380/415	50	4.0/2.3/2.3	960/960/965	IE1 76.6%/76.6%/76.3%	LT

MITSUBISHI ELECTRIC AUTOMATION (THAILAND) CO.,LTD.

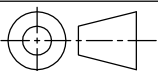

DIMENSION IN mm.

SCALE : NTS.

OUTLINE DRAWING NO.

0 N M 9 4 0 1 9 8

REV.

C