

MOTOR SPECIFICATION SHEET

MODEL : SF-PRVO 2.2kW 2P IP55

USED FOR : 200V CLASS

MANUFACTURER : MITSUBISHI ELECTRIC AUTOMATION (THAILAND) CO.,LTD.

DESCRIPTION	DETAIL		
PHASE	3		
MODEL NAME	SF-PRVO		
RATED OUTPUT	2.2 kW		
POLE	2		
CODE	MEATH CODE : 1M002V-200220PVDIO		
OUTLINE DRAWING NO.	ONM94O422-A		
RATED VOLTAGE (V)	200	200	
RATED FREQUENCY (Hz)	50	60	
RATED CURRENT (A)	8.4	8.2	
RATED SPEED (min ⁻¹)	2895	3480	
RATED EFFICIENCY (%)	89.5	89.6	
EFFICIENCY CLASS	IE3		
THERMAL CLASS	120(E)		
RATING	S1 (CONTINUOUS)		
ENCLOSURE CONSTRUCTION	TOTALLY ENCLOSED FAN COOLED		
DEGREES OF PROTECTION	IP55 (OUTDOOR DUST&WATER JET PROOF)		
METHOD OF COOLING	IC411		
FRAME NO.	90L		
WEIGHT (kg)	24		
STANDARD	IEC 60034-1, IEC 60034-30-1		
INSTALLATION	FLANGE MOUNTED (VERTICAL)		
ROTATION	CCW (VIEWED FROM SHAFT END)		
BEARING	LOAD SIDE	: 6205ZZ	
	OPPOSITE SIDE	: 6205ZZ	
BEARING GREASE	UREA GREASE		
NOISE (dB.A) *	50Hz : 61 / 60Hz : 65		
VIBRATION	V15		
CIRCUMSTANCE CONDITION	AMBIENT TEMPERATURE	: -30 ~ +40°C	
	AMBIENT HUMIDITY	: 100%RH (NO CONDENSATION)	
	ABOVE SEA LEVEL	: 1000m OR LESS	
	ENVIRONMENT	: NO CORROSIVE/EXPLOSIVE GAS, NO STEAM OR CONDENSATION, MINIMAL DUST.	
COLOR	MUNSELL N7 (GRAY)		
TERMINAL BOX	NO. OF LEAD WIRES	: 3	
	SOURCE CONNECTION	: TERMINAL BLOCK	
SHAFT SWING	≤0.03mm		
MATERIAL	FRAME	: STEEL PLATE	
	BRACKET	LOAD SIDE	: CAST IRON (FLANGE)
		OPPOSITE SIDE	: ALUMINIUM
	SHAFT	: CARBON STEEL	
	STATOR CORE	: ELECTRICAL STEEL	
	WIRE	: ENAMELLED COPPER MAGNET WIRE	
	ROTOR CORE	: ELECTRICAL STEEL	
	CONDUCTOR	: ALUMINIUM	
	TERMINAL BOX	: STEEL PLATE	
	PAINTING	: POLYURETHANE RESIN	
PRODUCTION COUNTRY	THAILAND		

*Value indicates representative value, not guaranteed value.

Specifications subject to change without notice.

SPECIFICATION SHEET NO.				
SS-N-9103-A				

MODEL SF-PRVO THREE PHASE INDUCTION MOTOR OUTLINE DRAWING

OUTDOOR DUST & WATER JET PROOF MOTOR

TOTALLY ENCLOSED FAN COOLED TYPE
 DEGREES OF PROTECTION IP55
 FLANGE NO. FF165

CUSTOMER _____
 USER _____
 FOR _____
 CUSTOMER'S ORDER NO. _____
 QUANTITY _____
 MFG. ORDER NO. _____

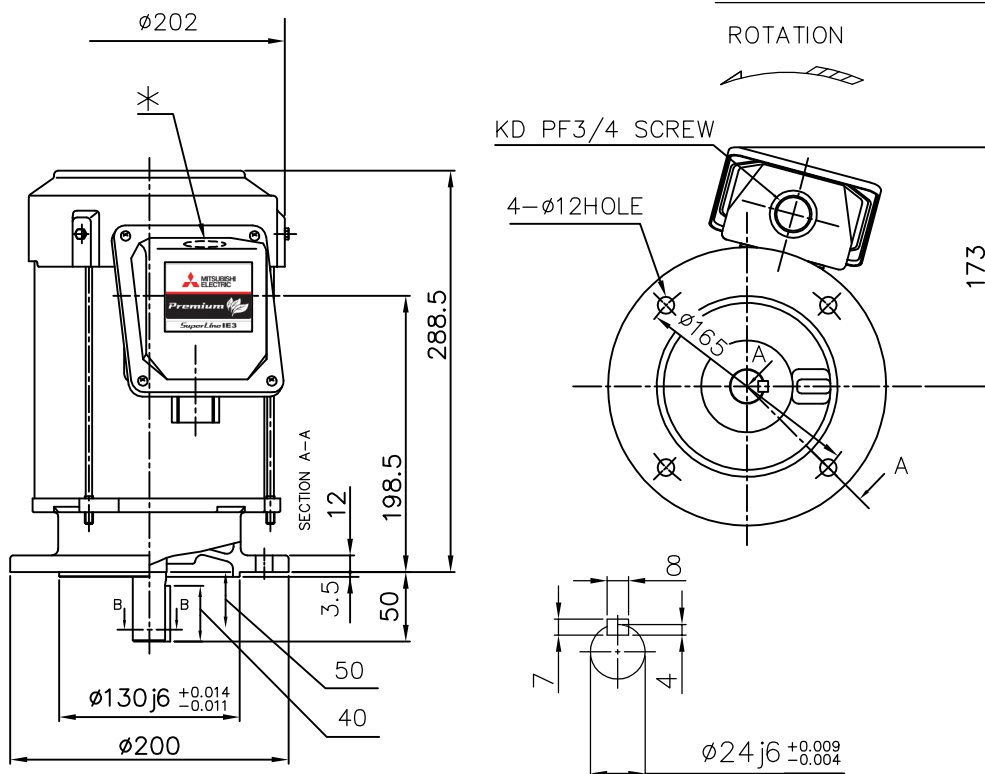

REMARK:

* =



NOTE :

GAP OF HOLE BETWEEN SHAFT-BRACKET HAVE NOT PROTECTION WATER PROOF SO PLEASE SEAL WITH FLANGE IN-ROW BY YOUR SELF.

SECTION B-B

YOUR ORDER	FRAME SIZE	RATING	TH. CLASS	AMB. TEMP.	BEARINGS		COLOR	DIRECTION OF ROTATION (VIEWED FROM SHAFT END)	NO. OF TERMINALS	REMARKS
					LOAD SIDE	OPP. SIDE				
	90L	S1 (CONT.)	120(E)	40°C	6205ZZ	6205ZZ	GRAY (MUNSELL N7)	CCW	3	

YOUR ORDER	OUTPUT		RATE VOLTAGE	IE CODE-RATED EFF.						MASS(Kg)
	kW	POLE		50Hz				60Hz		
				200V	380V	400V	415V	200V	400V	
	1.5	2	200V 50Hz 200V 60Hz	IE3-89.4%	-	-	-	IE3-89.3%	-	22
	1.5	2	380/400/415V 50Hz 400V 60Hz	-	IE3-88.8%	IE3-89.4%	IE3-89.6%	-	IE3-89.3%	22
	2.2	2	200V 50Hz 200V 60Hz	IE3-89.5%	-	-	-	IE3-89.6%	-	24
	2.2	2	380/400/415V 50Hz 400V 60Hz	-	IE3-88.8%	IE3-89.5%	IE3-89.8%	-	IE3-89.6%	24
	1.5	4	200V 50Hz 200V 60Hz	IE3-86.9%	-	-	-	IE3-88.6%	-	23
	1.5	4	380/400/415V 50Hz 400V 60Hz	-	IE3-86.7%	IE3-86.9%	IE3-86.6%	-	IE3-88.6%	23

MITSUBISHI ELECTRIC AUTOMATION(THAILAND)CO.,LTD

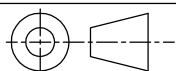

DIMENSION IN mm.
 SCALE : NTS

OUTLINE DRAWING NO.

REV.

0 N M 9 4 0 4 2 2

A